

# User Manual

## SpeedyBee F745 35A BLS AIO

### contents

#### Part 1 - OverView

- Specifications 1
- Dimensions 2
- Package 3
- Layout 4

#### Part 2 - Flight Controller

- Wiring Diagram 5
- App 6
- FC Firmware Update 7
- BlackBox Analyzer 8

#### Part 3 - ESC

- Connection with Motors & Power Cable 9
- ESC Configuration 10
- ESC Firmware Update 11

Overview	
Product Name	SpeedyBee F745 35A BLS AIO
Power Input	3S - 6S Lipo
Mounting	25.5 x 25.5mm, 3mm hole diameter
Dimension	36.5mm(L) x 36.5mm(W) x 7mm(H), recommended for quads at 3.5" or above
Weight	10.1g
FC	
MCU	STM32F745
IMU(Gyro)	MPU6000
USB Connection	Need to solder a USB TYPE-C module to D+,D-,GND pads.
Barometer	BMP280
OSD	Supported
BLE Bluetooth	Supported. Used for parameter configuration built-in a single 2.4 GHz Wi-Fi-and-Bluetooth combo chip
Flash FC Firmware Wirelessly	Supported
Download/Analyze Blackbox	Supported
DJI Air Unit 6-pin Connector	Built-in.
Flash(for BlackBox)	8MB
Current Sensor	Supported. Scale=256
BetaFlight Camera Control Pad	Yes(CC pad)
5V Output	4 groups of 5V output. The total current load is 2.5A.
9V Output	None
ESC Signal Pads	M1 - M4
UART	Full UART * 4(UART1, UART2, UART3,UART4)
ESC Telemetry UART	None
I2C	Supported.
LED Pad	Used for WS2812 LED
Buzzer	BZ+ and BZ- pad used for 5V Buzzer
BOOT Button	Used to enter DFU mode
RSSI Input	Not supported
SmartPort	Not supported
Supported Flight Controller	BetaFlight(Default)
Firmware Firmware Target Name	SPEEDYBEE F745AIO
ESC	
Power Input	3-6S LiPo
Continuous Current	35A * 4
Burst Current	45A(5S)
ESC Protocol	DSHOT300/600
Power Output	VBAT
Current Sensor	Supported(Sacle=256)
Firmware	BLHeli_S J-H-40

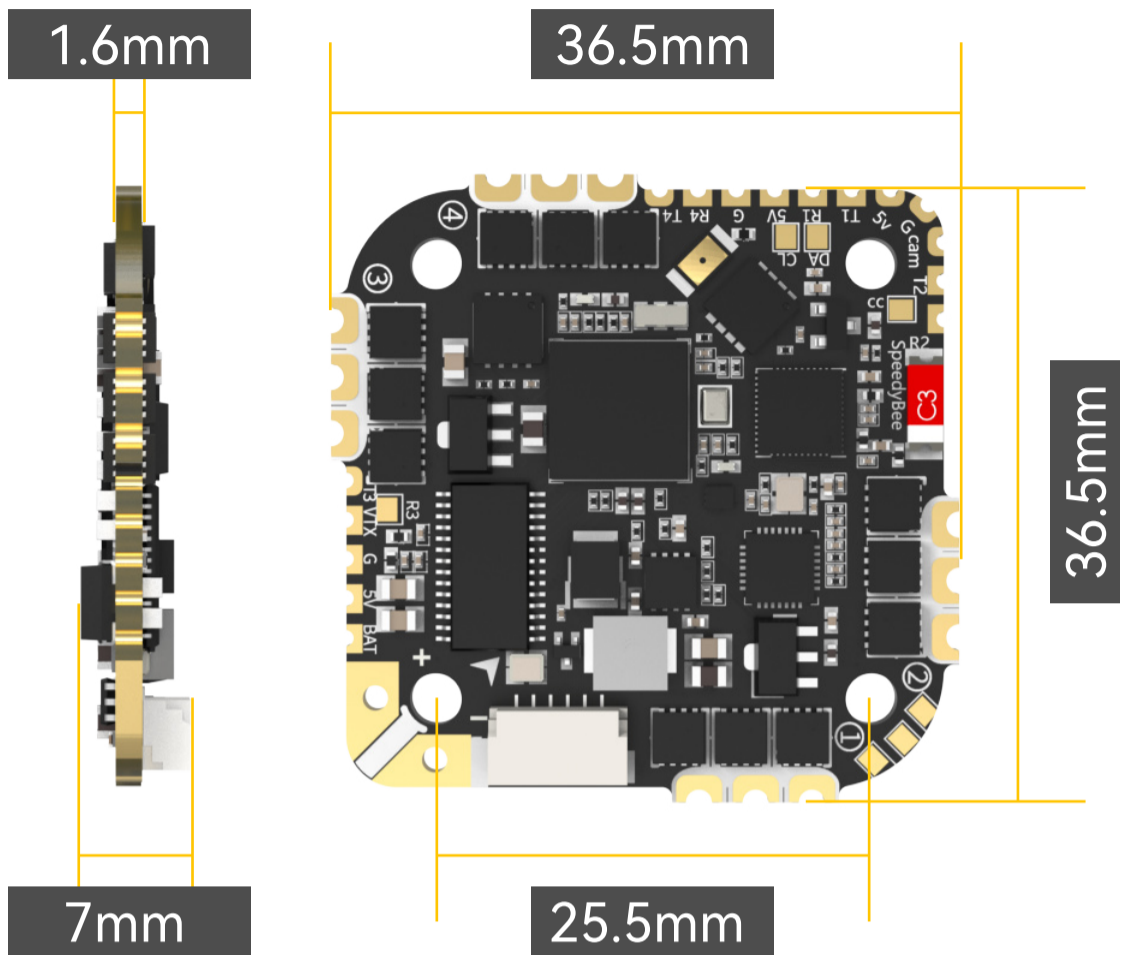

# Package

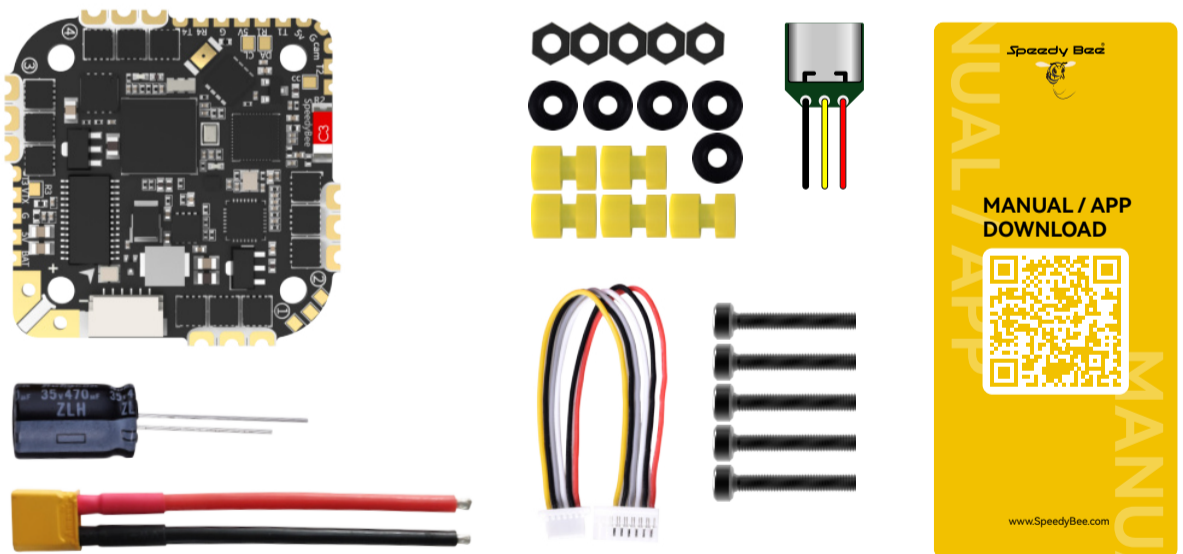

- SpeedyBee F745 35A BLS AIO x 1
- 35V 470uF Capacitor x 1
- XT30 Power Cable(Length: 7cm) x 1
- 6pin DJI Air Unit cable x 1
- External USB Port module(Wire Length: 5mm) x 1
- M2(Diameter) \* 12mm(Length) Screw x 5
- M2(Hole Diameter) \* 6.6mm(Height) Anti-vibration Silicone Grommets x 5
- M2 Silicone O-Ring x 5
- M2 Nylon Hex Nut x 5
- Manual & App Download Card x 1

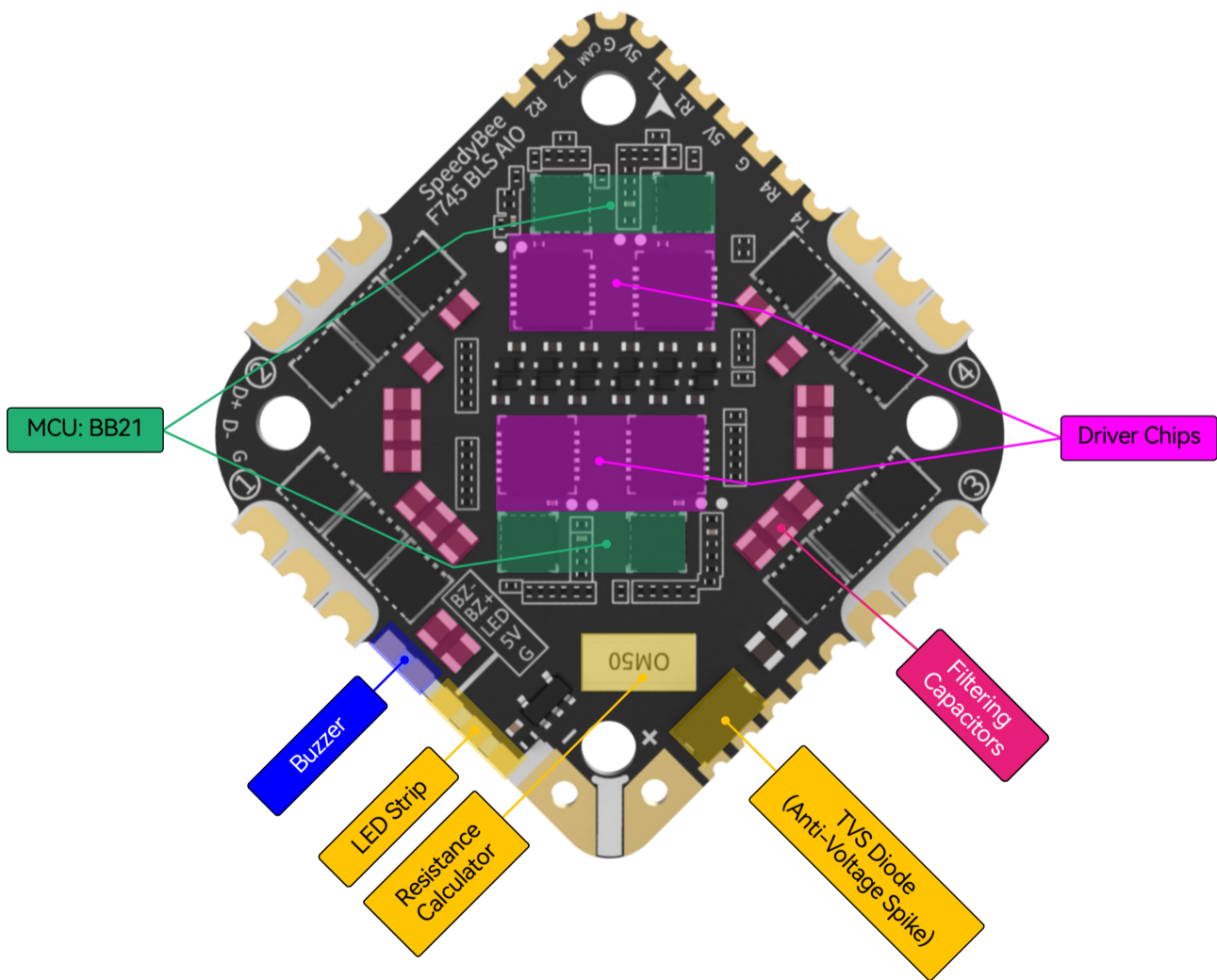
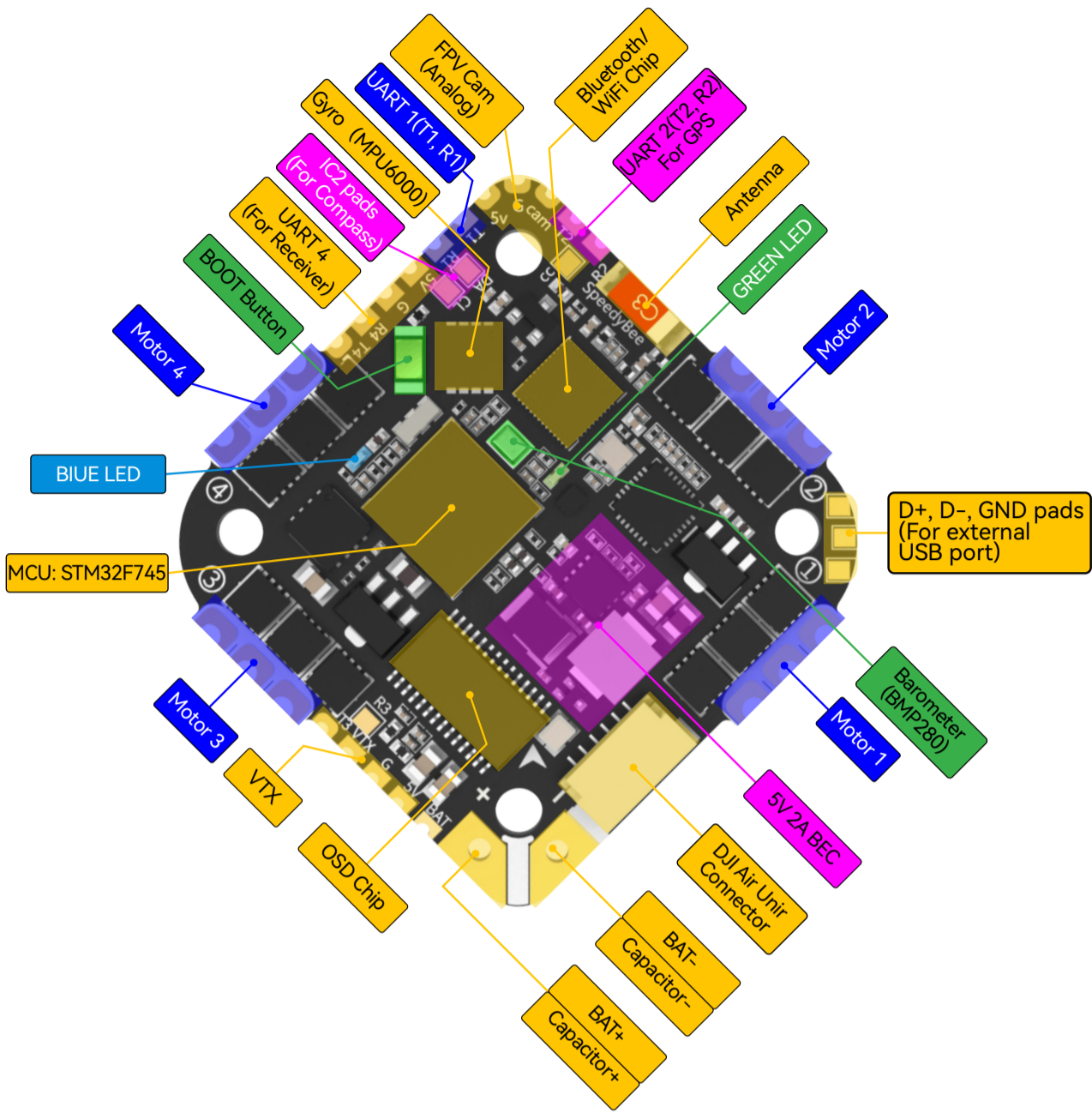

## ■ LED Indicator Definition

■ GREEN LED - Solid Green indicates Bluetooth is connected.

■ BLUE LED - Flight controller status light which is controlled by the flight controller firmware.

## ■ BOOT Button

Only if the flight controller gets bricked , please follow these steps to re-flash firmware for it:

1. Hold the BOOT button (the only button on the FC), and power to FC at the same time, then the FC will enter DFU mode.
2. Open the SpeedyBee app, go to the FC Firmware Flashing page, and perform the Firmware Flashing as prompted.

# Part 2 - Flight Controller

## Wiring Diagram

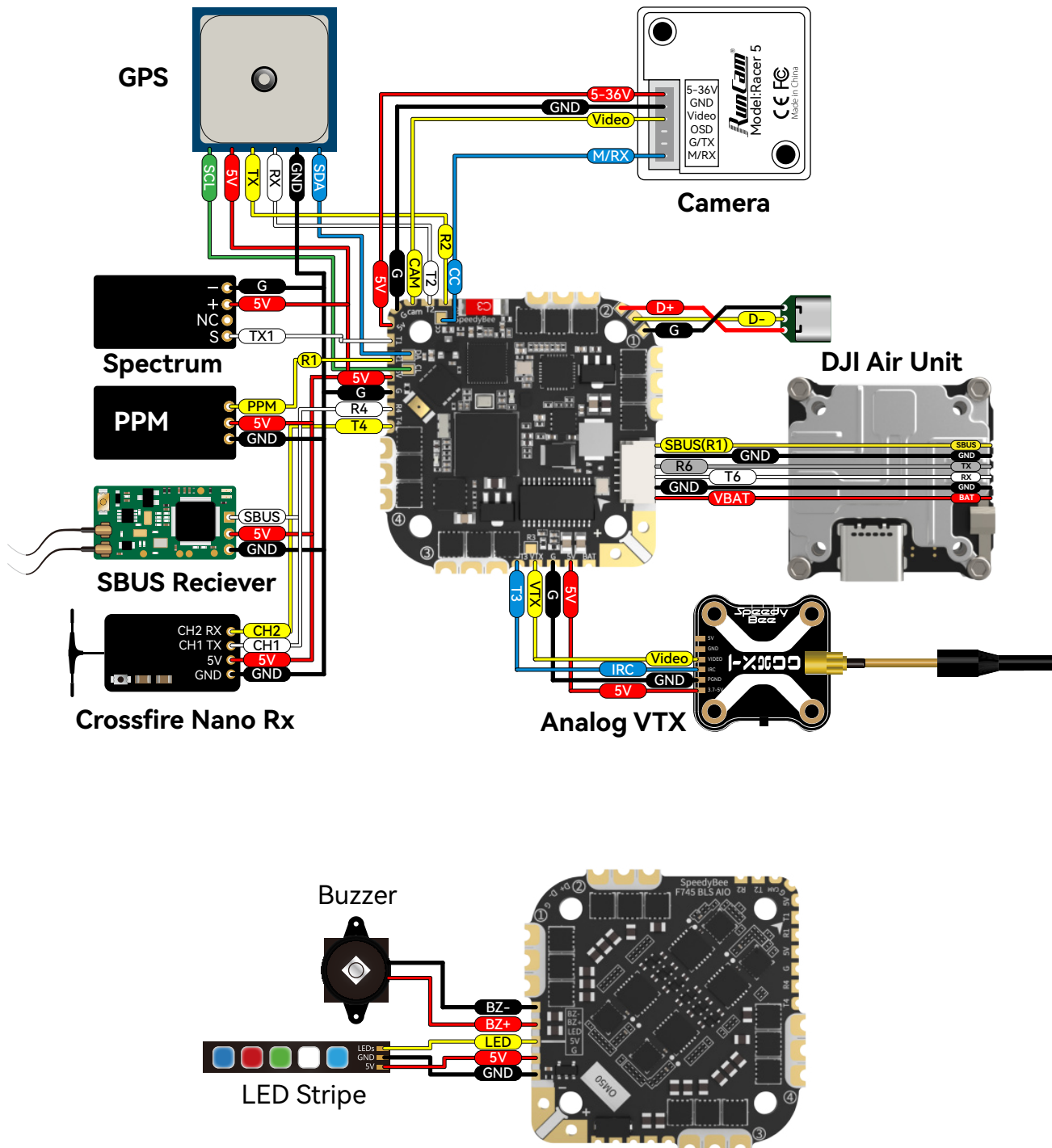

### USB-C Module\*

\* Due to the size limitation, there's no 5V output from the FC to the USB-C module, so you need to power the AIO with a battery before you connect the AIO flight controller to your computer with a USB-C cable.

## ■ Get the SpeedyBee App

Search 'SpeedyBee' on Google Play or App Store. Or download the Android .apk file on our website: <https://www.speedybee.com/download>.

## Connect the App

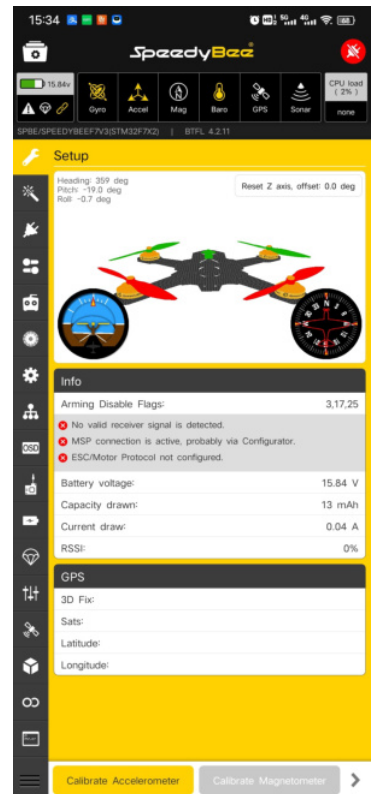
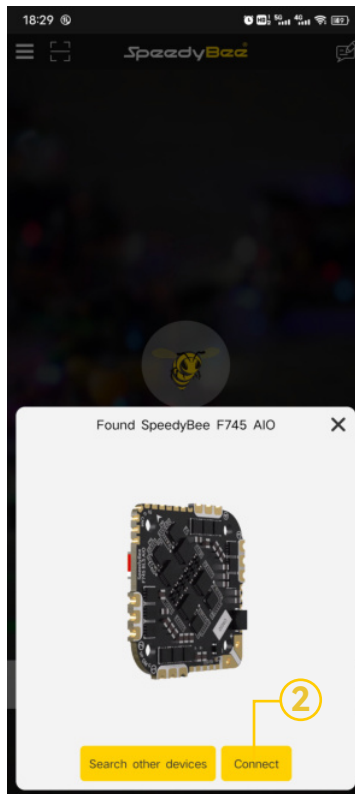
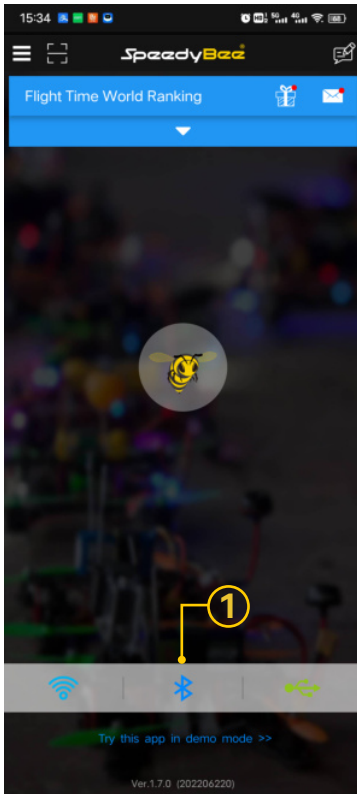

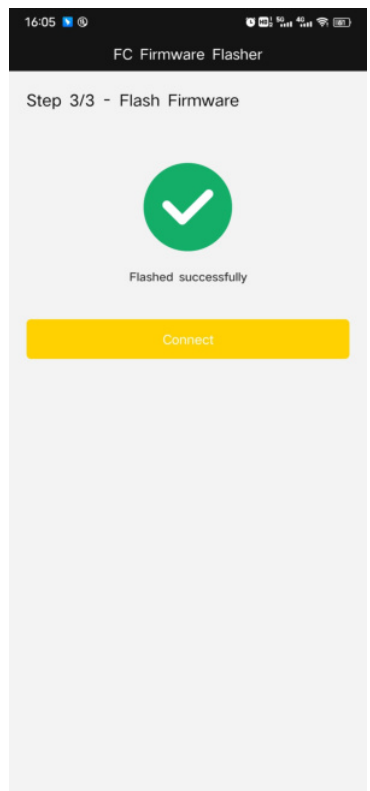
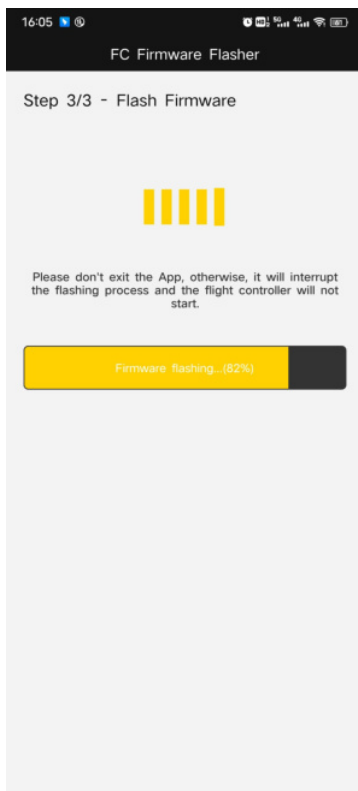
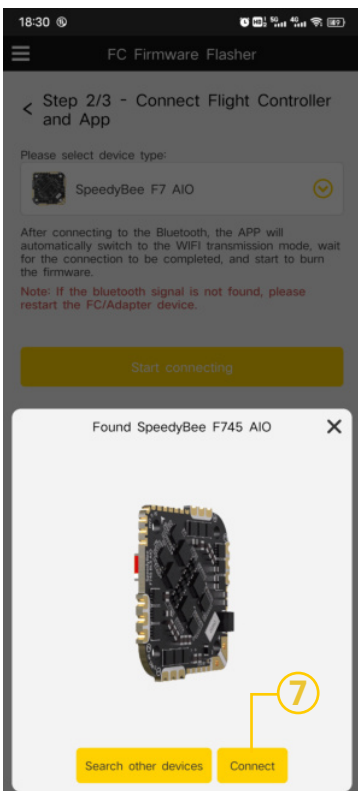
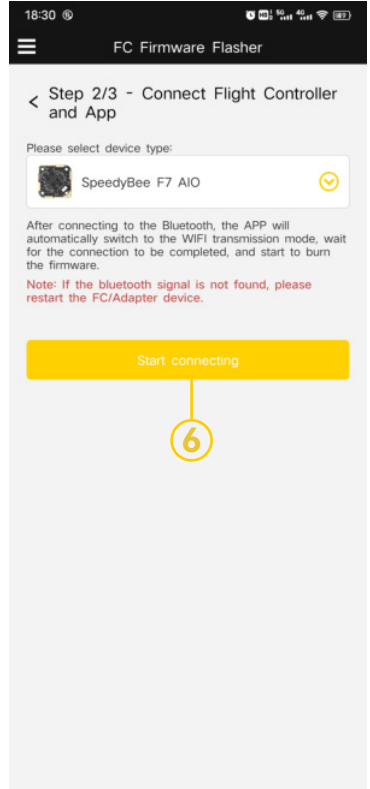
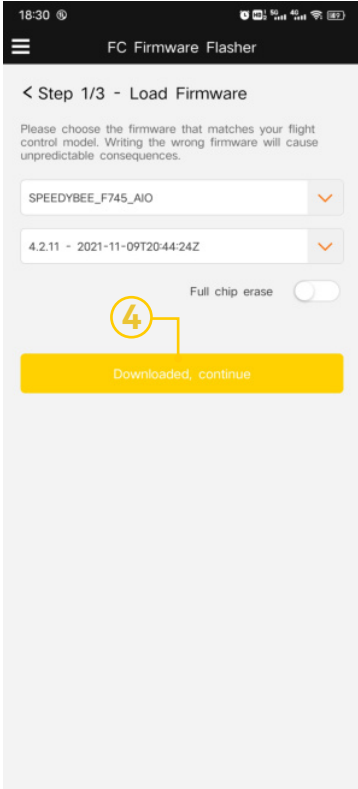
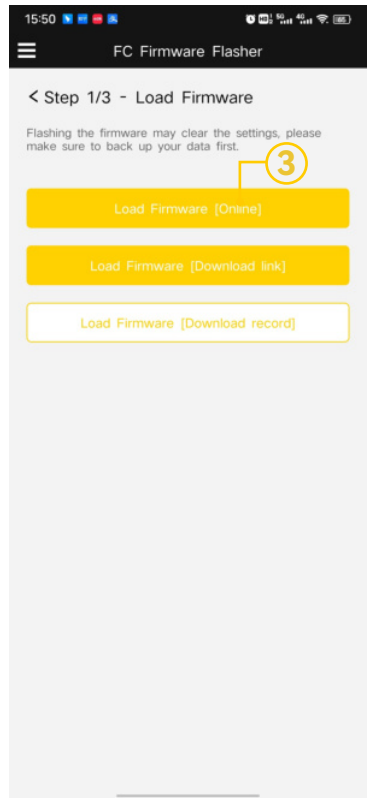
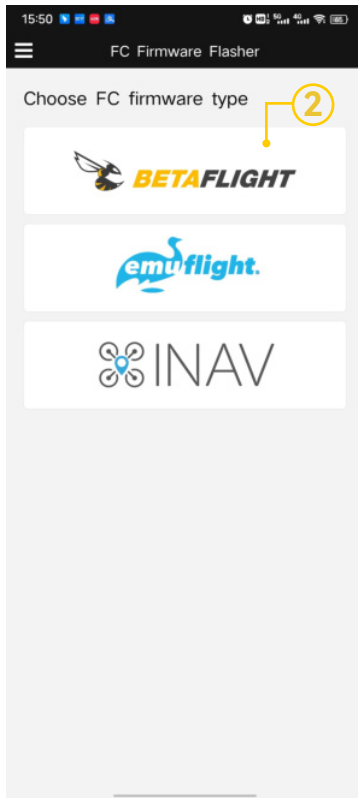
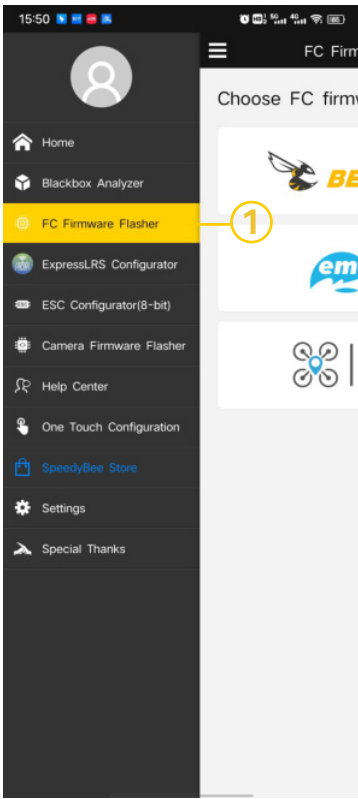

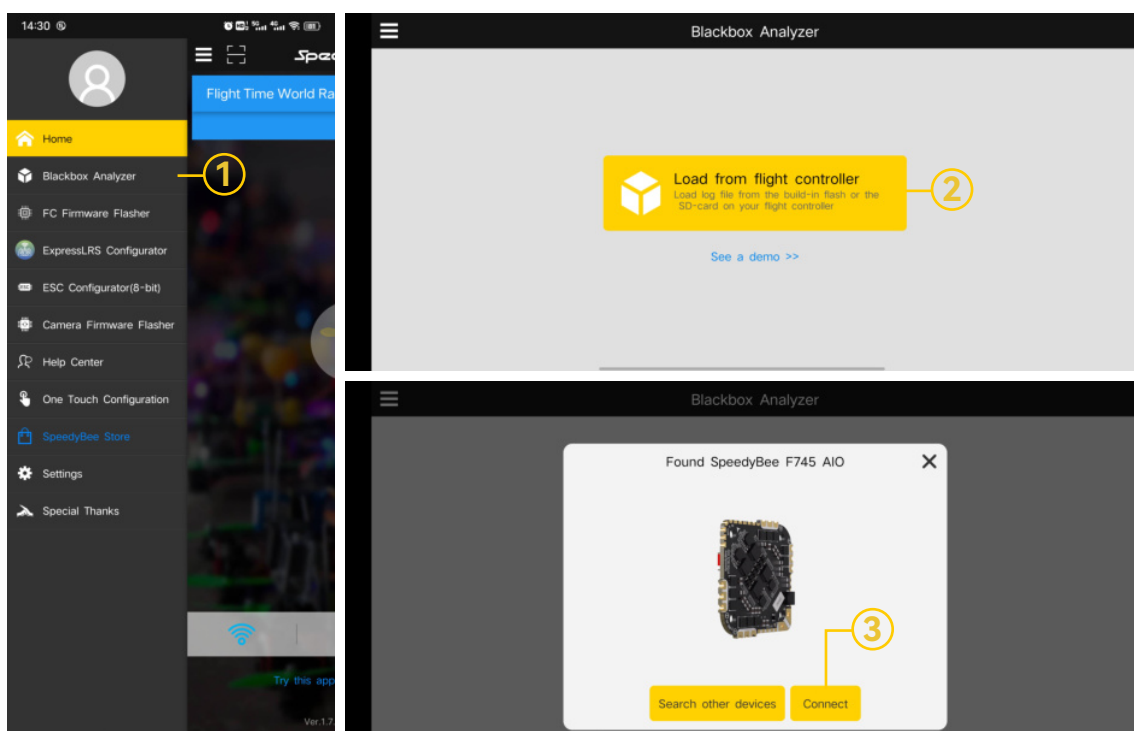

## Part 3 - ESC

### Connection with Motors & Power Cable

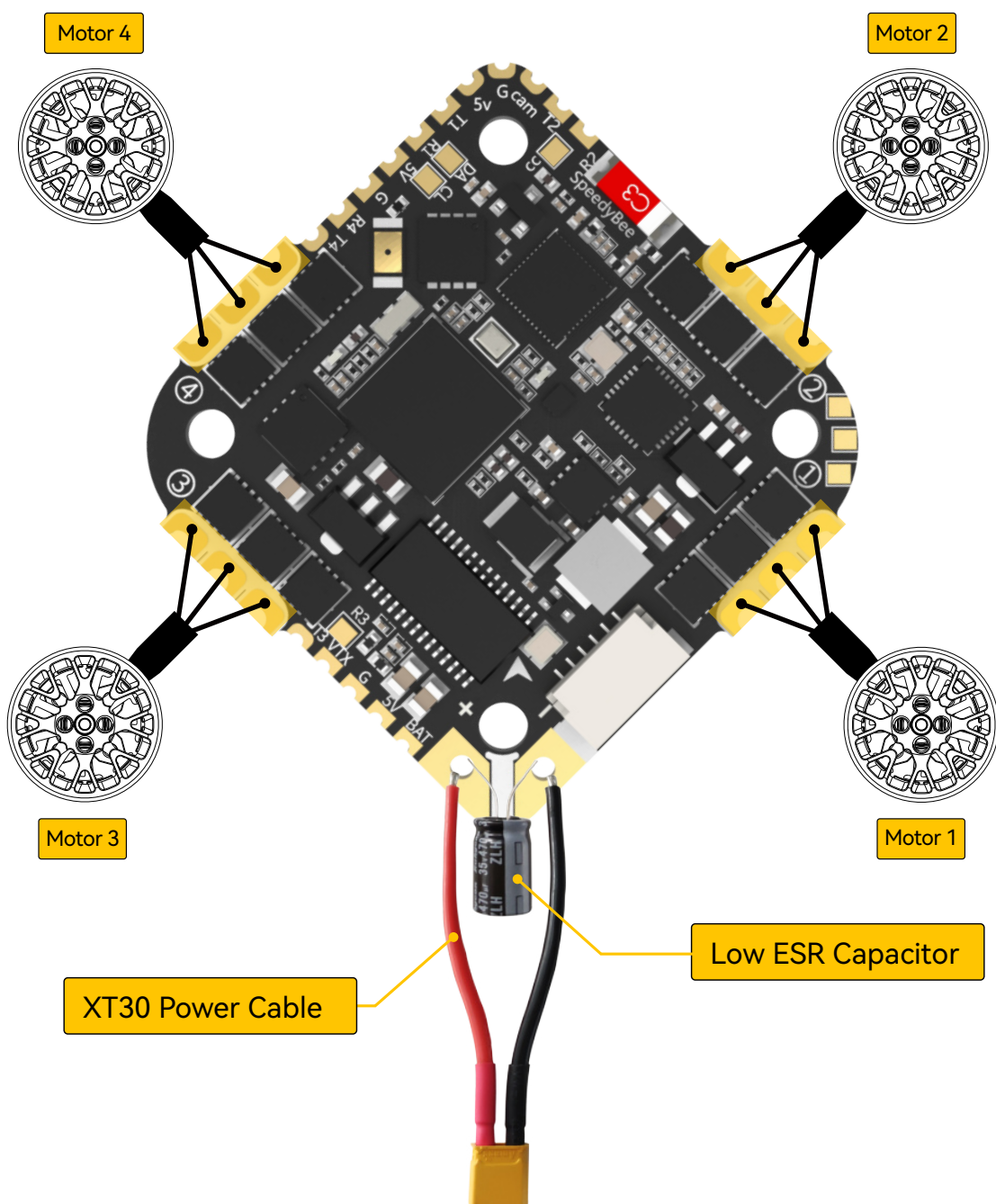

- **Note:** In order to prevent the AIO from being burnt out instantaneous voltage spikes on powering up, it is strongly recommended to use the Low ESR capacitor in the package.



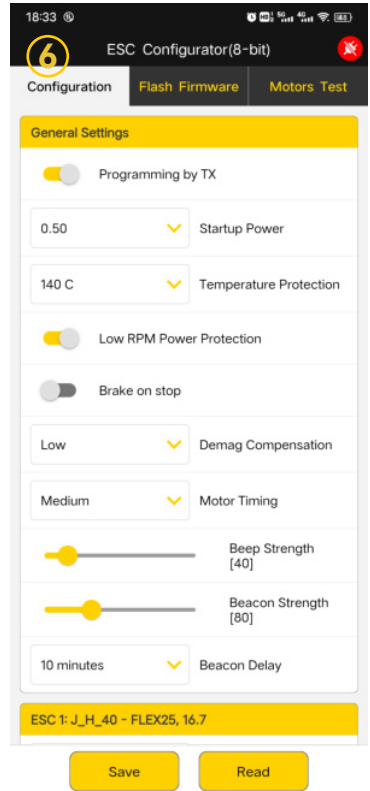
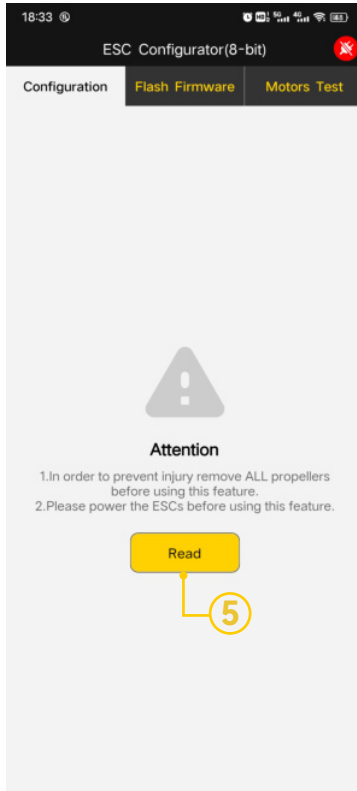
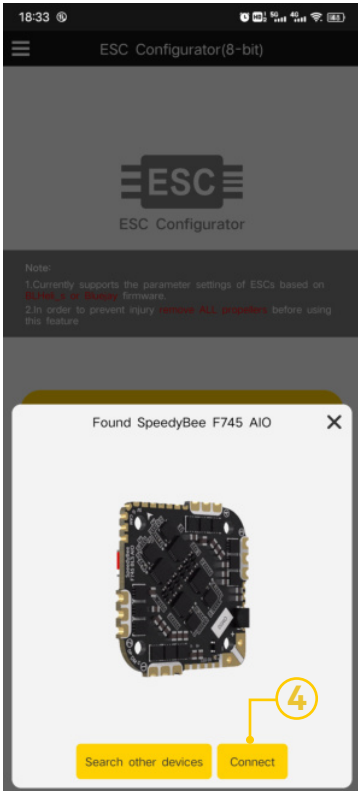
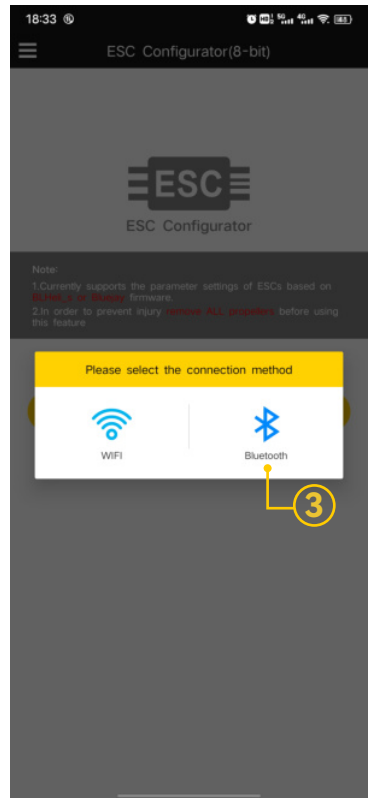
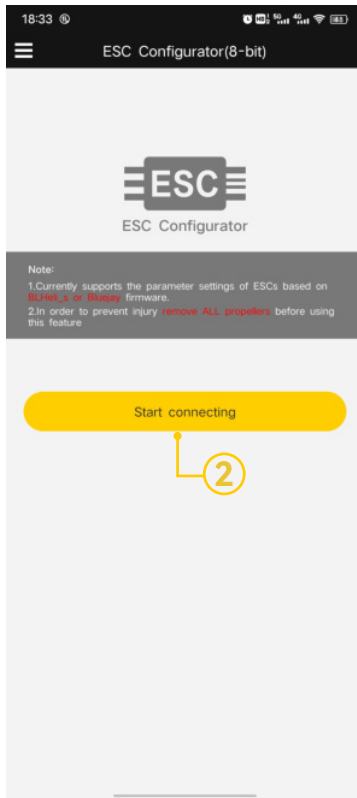
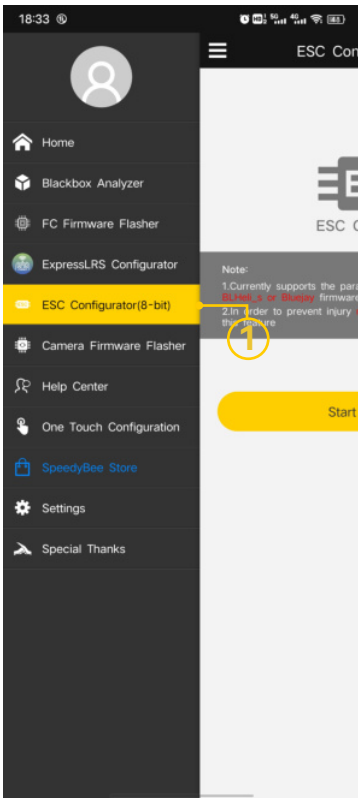

- You could flash both **BLHeli\_S** and **Blue Jay** firmware for this ESC.

You need to plug in the battery to the AIO and then connect a USB cable between the AIO and your PC. Then flash ESC firmware (BLHeli\_S or Blue Jay) in the following online configurator:

<https://esc-configurator.com/>

Note: ESC Type should be set as 'J-H-40'.

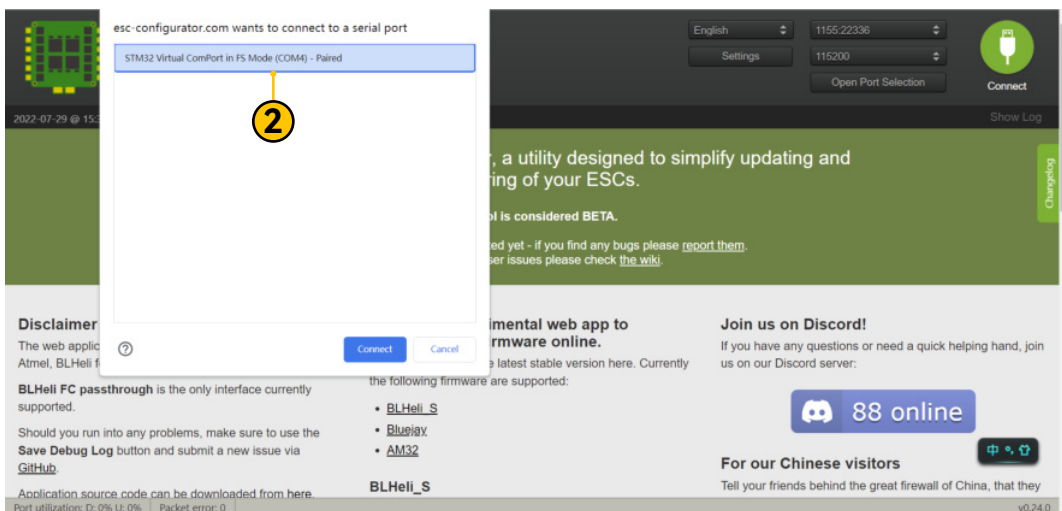
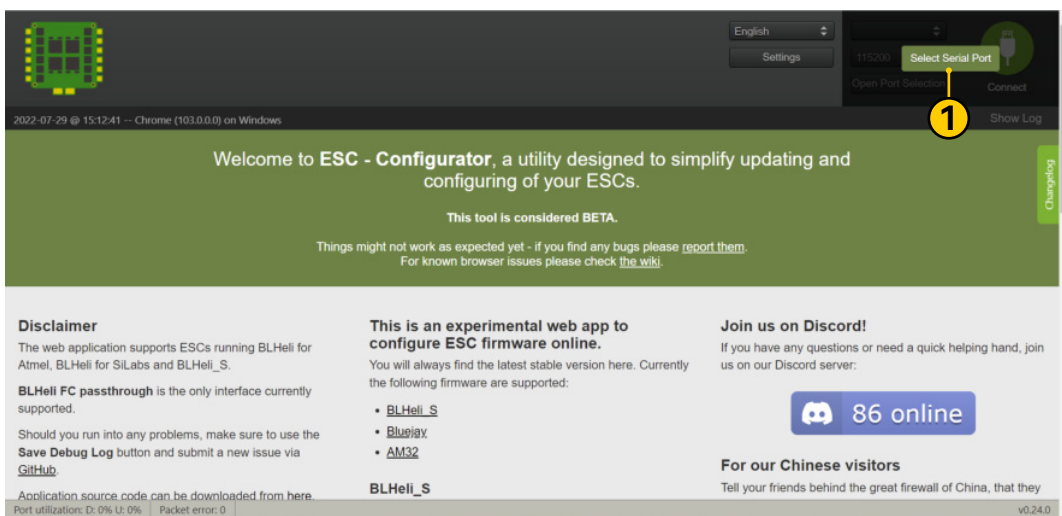

English 1155:22336  
Settings 115200  
Open Port Selection Connect

2022-07-29 @ 15:23:54 -- Port selected Show Log

## Welcome to ESC - Configurator, a utility designed to simplify updating and configuring of your ESCs.

This tool is considered BETA.

Things might not work as expected yet - if you find any bugs please [report them](#).  
For known browser issues please check the [wiki](#).

**Disclaimer**  
The web application supports ESCs running BLHeli for Atmel, BLHeli for SiLabs and BLHeli\_S.

**BLHeli FC passthrough** is the only interface currently supported.

Should you run into any problems, make sure to use the **Save Debug Log** button and submit a new issue via [GitHub](#).

Application source code can be downloaded from [here](#).  
Port utilization: D: 0% U: 0% Packet error: 0

**This is an experimental web app to configure ESC firmware online.**  
You will always find the latest stable version here. Currently the following firmware are supported:

- [BLHeli\\_S](#)
- [Bluejay](#)
- [AM32](#)

**Join us on Discord!**  
If you have any questions or need a quick helping hand, join us on our Discord server:

**86 online**

**For our Chinese visitors**  
Tell your friends behind the great firewall of China, that they

v0.24.0

English 1155:22336  
Settings 115200  
Open Port Selection Disconnect

2022-07-29 @ 15:24:27 -- Unique device ID received - 0x04300423039510c35383236 Show Log

**Note:** Make sure you've taken the propellers OFF before doing anything on this tab.  
**Note:** Connect power to the ESCs.

### Motor Control

Make sure your ESCs are properly set up to reflect the state of the sliders.  
Eg.: When you enabled 3D mode in your flight controller, make sure the ESCs are also set up for 3D mode, otherwise the motors might go off with full power.

Also be aware that the motors will not spin if you have bi-directional Dshot enabled on the Flight-controller, but the ESC does not support it. Which might be the case when flashing from RPM enabled firmware to BLHeli\_S.

Enable motor control **Battery: 25 @ 7.16V**

**Motor 1** 1000 **Master Speed** 1000

**Motor 2** 1000

Save Debug Log Clear Debug Log Restore Default Settings Flash All ESCs Write Settings Read Settings

Port utilization: D: 0% U: 0% Packet error: 0 v0.24.0

English 1155:22336  
Settings 115200  
Open Port Selection Disconnect

2022-07-29 @ 15:24:41 -- Done reading ESCs Show Log

**Note:** Make sure you've taken the propellers OFF before doing anything on this tab.  
**Note:** Connect power to the ESCs.

### Common Parameters

Programming by TX

0.50 Startup Power ?  
140 C Temperature Protection ?  
 Low RPM Power Protection  
 Brake on stop ?  
Low Demag Compensation ?  
Medium Motor Timing ?  
40 Beep Strength ?

### ESC 1: J-H-40 - BLHeli\_S, 16.7

Reversed Motor Direction ?  
1148 µs PPM Min Throttle  
1832 µs PPM Max Throttle  
Off LED Configuration  
Flash Firmware to this ESC

### ESC 2: J-H-40 - BLHeli\_S, 16.7

Reversed Motor Direction ?

Save Debug Log Clear Debug Log Restore Default Settings Flash All ESCs Write Settings Read Settings

Port utilization: D: 0% U: 0% Packet error: 0 v0.24.0

English 1155:22336  
Settings 115200  
Open Port Selection Disconnect

2022-07-29 @ 15:24:41 -- Done reading ESCs Show Log

Ignore inappropriate MCU and Layout?  
 Migrate settings between different firmwares?

**Note:** Be aware that settings are not migrated between different firmwares, make sure to take note of your motor directions and other settings you might want to move over. Settings will be migrated between different versions of the same firmware.

### Select Target (J-H-40 - BLHeli\_S, 16.7)

BLHeli\_S Firmware  
J-H-40 ESC  
16.7 [Official] Version

Flash  
Flash Local Firmware  
Cancel

Port utilization: D: 0% U: 0% Packet error: 0 v0.24.0